

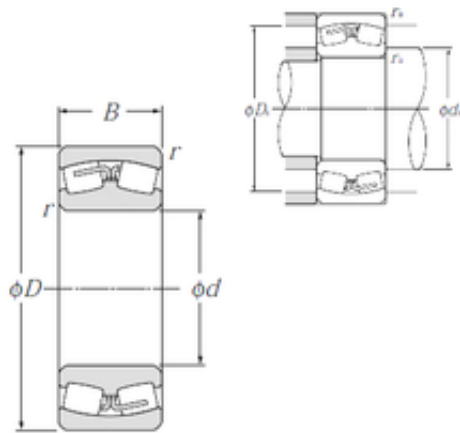

China ucp205 Bearing Supplier

240/800B NTN Spherical Roller Bearings



Bearing No. 240/800B

Size	800x1150x345 mm
Bore Diameter	800 mm
Outer Diameter	1150 mm
Width	345 mm
d	800 mm
D	1 150 mm
B	345 mm
C	345 mm
r min.	7,5 mm
da min.	836 mm
Da max.	1 114 mm
ra max.	6 mm
Weight	1 190 Kg
Basic dynamic load rating (C)	11 200 kN
Basic static load rating (C0)	27 800 kN
(Grease) Lubrication Speed	200 r/min
(Oil) Lubrication Speed	260 r/min
Calculation factor (e)	0,28
Calculation factor (Y0)	2,36
Calculation factor (Y1)	2,41

240/800B Bearing 2D drawings and 3D CAD models